

# SI SERIES

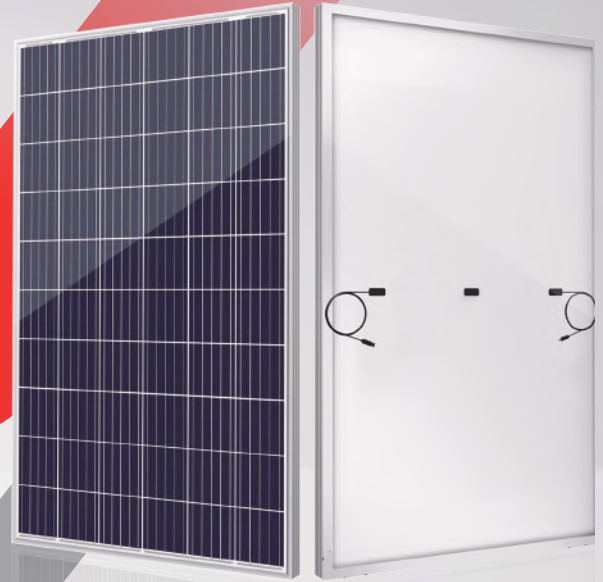



## 270-285<sub>w</sub>



### ● SI SERIES

On the 156.75mm silicon wafers, seraphim rely on the advanced technology and unique understanding of materials throughout the product design, to ensure the stable power output of the module, and effectively improve the efficiency and reliability of the modules.

### ● KEY FEATURES

-  Less mismatch to get more power
-  Less power loss by minimizing the shading impact
-  Competitive low light performance
-  3 times EL test to ensure best quality
-  Ideal choice for utility and commercial scale projects by reduced BOS and improve ROI.

### ● QUALITY SYSTEM

ISO19001 / ISO14001 / OHSAS18001

### ● PRODUCT CERTIFICATION



### ● INSURANCE **PICC**

### ● WARRANTY

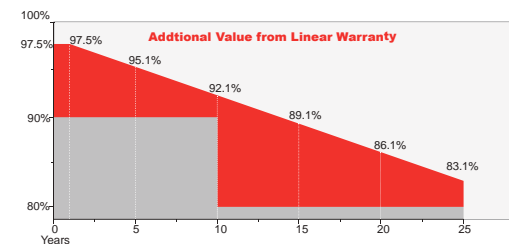

**10 YEARS** Guarantee on product material and workmanship

**25 YEARS** linear power output warranty



**SRP-XXX-6PB**      SERIES 6 INCH 60

**Electrical Characteristics**

Module Type	SRP-270-6PB		SRP-275-6PB		SRP-280-6PB		SRP-285-6PB	
	STC	NOCT	STC	NOCT	STC	NOCT	STC	NOCT
Maximum Power -P <sub>mp</sub> (W)	270	200	275	204	280	208	285	212
Open Circuit Voltage -V <sub>oc</sub> (V)	38.1	35.2	38.3	35.4	38.5	35.6	38.7	35.8
Short Circuit Current -I <sub>sc</sub> (A)	8.99	7.26	9.08	7.35	9.18	7.44	9.27	7.53
Maximum Power Voltage -V <sub>mp</sub> (V)	31.3	29.2	31.6	29.4	31.8	29.6	32.0	29.8
Maximum Power Current -I <sub>mp</sub> (A)	8.63	6.85	8.71	6.94	8.81	7.03	8.91	7.12
Module Efficiency STC-η <sub>m</sub> (%)	16.60		16.90		17.21		17.52	
Power Sorting (W)	( 0 ~ +4.99 )							
Maximum System Voltage (V)	1000V DC							
Maximum Series Fuse Rating (A)	20A							
Pmax Temperature Coefficient	-0.36 %/°C							
Voc Temperature Coefficient	-0.30 %/°C							
Isc Temperature Coefficient	+0.05 %/°C							
Operating Temperature	-40~+85 °C							
Nominal Operating Cell Temperature	45±2 °C							

STC: Irradiance 1000 W/m<sup>2</sup> module temperature 25°C AM=1.5  
 NOCT: Irradiance 800 W/m<sup>2</sup> ambient temperature 20°C wind speed :1m/s  
 Power measurement tolerance: +/-3%

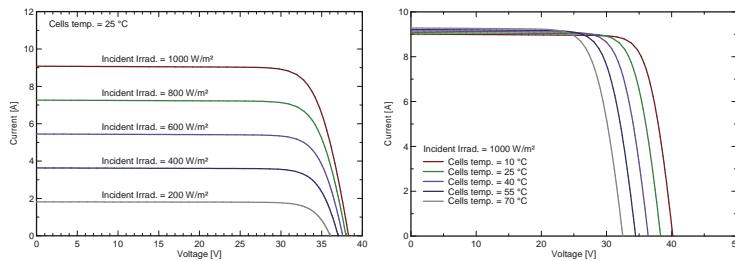
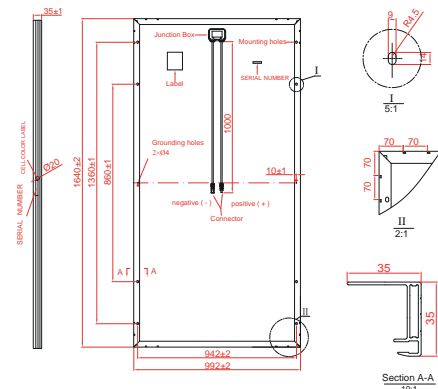
**I-V Curve**

**Technical drawing(SRP-XXX-6PB)**

\* All Dimensions in mm.

\* The above drawing is a graphical representation of the product.  
 For engineering quality drawings please contact SERAPHIM.

**Mechanical Specifications**

External Dimension	1640 x 992 x 35mm
Weight	17.5kg
Solar Cells	Poly crystalline 156.75 x 156.75 mm (60pcs)
Front Glass	3.2 mm AR coating tempered glass, low iron
Frame	Anodized aluminium alloy
Junction Box	IP68, 3 diodes
Output Cables	4.0 mm <sup>2</sup> , cable length:1000 mm
Mechanical Load	Front side 5400Pa/ Rear side 2400Pa
Connector	Genuine MC4 / 05-6
Fire Safety Class	Class C

**Packing Configuration**

External Dimension	1640 x 992 x 35mm	
Container	20'GP	40'HQ
Pieces per Pallet	31	31+2*
Pallets per Container	12	26
Pieces per Container	372	858

\* 31+2 pieces per pallet is the special package which only suits for container transport. For details, please consult SERAPHIM.

